

# PARTICLE SUCTION EXTRACTION SYSTEM



INSTRUCTION MANUAL

C|PS<sup>2</sup> - ESD

FOCUS ON PARTICLES



You must read these operating instructions and all relevant documents before using the system.

Document C|PS<sup>2</sup> ESD particle suction extraction system  
Item no.: 6003490  
Operating instructions – English translation

Version V 1.1 / Date 01.02.2021

Other documents relevant for this product:

- EC Declaration of Conformity for FESTOOL mobile dust extractor
- Original operating instructions – FESTOOL mobile dust extractor CTL MINI I, CTL MIDI I, CTL MINI, CTL MIDI
- Original operating instructions for differential pressure measuring instrument testo 526-1

---

**CleanControlling GmbH**  
Gehrenstrasse 11 a  
D-78576 Emmingen-Liptingen

Tel.: +49 (0)7465 929678-0  
Website: [www.cleancontrolling.com/en/](http://www.cleancontrolling.com/en/)

Fax: +49 (0)7465/929678-10  
Email: [info@cleancontrolling.de](mailto:info@cleancontrolling.de)

Copyright © 2019 CleanControlling GmbH

**Table of contents**

**1. Safety ..... 4**

1.1. Basic safety instructions ..... 4

1.1.1. Terminology ..... 4

1.1.2. Safety symbols and representations used ..... 4

1.1.3. Mandatory symbols ..... 5

1.1.4. Warning signs ..... 5

1.1.5. Conformity, guidelines and directives ..... 6

1.1.6. ESD conformity as per IEC 61340-5-1 ..... 6

1.1.7. Operator ..... 6

1.1.8. Obligation and liability ..... 6

1.1.9. Obligation to instruct ..... 7

1.1.10. Designated use ..... 7

1.1.11. Organizational measures and the owner's obligations ..... 7

1.1.12. Informal safety measure ..... 7

1.1.13. Training of staff ..... 8

1.1.14. Specific hazardous points ..... 8

1.1.15. Maintenance, servicing and fault repair ..... 8

1.1.16. Structural changes to the device ..... 8

1.1.17. Cleaning the device ..... 9

1.1.18. Noise from the device ..... 9

1.1.19. Decommissioning and disposing of the device ..... 9

1.1.20. Change of owner ..... 9

1.1.21. Guidelines for a safe work area ..... 10

1.2. Defective device ..... 10

1.3. Further use of components after suction extraction ..... 10

**2. Description ..... 11**

2.1. Particle suction extraction system with cyclone unit ..... 12

2.2. Particle suction extraction system without cyclone unit ..... 13

**3. Structure ..... 14**

3.1. Particle suction extraction system (example without flushing unit) ..... 14

3.2. ESD trolley ..... 15

**4. Initial operation ..... 17**

4.1. Initial operation ..... 28

4.2. Initial operation without cyclone unit ..... 30

4.3. Connecting the remote control and suction unit ..... 31

4.4. Resetting the remote control ..... 31

4.5. Deleting all stored Bluetooth connections of the suction unit ..... 32

**5. Particle suction extraction process ..... 33**

Contents

5.1.	Screwing on or replacing the particle collection jar.....	33
5.2.	Attaching or replacing the particle trap.....	34
5.3.	Replacing or inserting the mesh filter.....	35
5.4.	Flushing the mesh filter.....	36
5.5.	Setting and switching on the suction unit.....	37
5.6.	Carrying out the particle suction extraction procedure.....	38
5.7.	Instructions on using the suction and brush nozzles.....	40
5.8.	Differential pressure measurement.....	43
5.8.1.	Connection of the differential pressure measuring device.....	44
5.8.2.	Setting the differential pressure measuring device.....	45
5.8.3.	Using the timer.....	46
<b>6.</b>	<b>Cleaning.....</b>	<b>47</b>
6.1.	Cleaning equipment and carrying out thorough cleaning.....	47
6.1.1.	Preparing cleaning equipment and cleaning.....	47
6.1.2.	Cleaning hoses.....	49
6.1.3.	Cleaning the nozzles.....	51
6.1.4.	Cleaning the system.....	53
6.2.	Determining the blank value after cleaning.....	56
6.2.1.	Determining the blank value with or without the prefilter.....	56
6.2.2.	Determining the blank value.....	57
<b>7.</b>	<b>Maintenance.....</b>	<b>58</b>
7.1.	Replacing the suction unit filter and emptying the dirt container.....	58
<b>8.</b>	<b>Scope of delivery/equipment.....</b>	<b>59</b>

## 1. Safety

### 1.1. Basic safety instructions

#### 1.1.1. Terminology

<b>ESD</b>	=	Electrostatic discharge
<b>ESDS</b>	=	ESD-sensitive components
<b>EPA</b>	=	ESD-protected area

#### 1.1.2. Safety symbols and representations used

##### Format for warnings

Signal words are used in conjunction with safety warning symbols to highlight warnings.

##### Signal words

The three signal words WARNING, CAUTION and NOTICE used in these instructions indicate possible injury or damage to equipment. The signal words may also precede the main text and have the following meanings:



A WARNING refers to a potential danger which can cause serious injuries or even death if not avoided.



CAUTION refers to a potential danger which can cause slight injuries if not avoided.



The word NOTICE indicates a potential danger which can cause damage to the device.

##### Other symbols

The following symbols are also used.



The text next to this symbol provides additional important information.





Text featuring this symbol requires you to take action.

- This symbol is a bullet point for lists.





### 1.1.3. Mandatory symbols

Mandatory instructions and symbols are used within warning symbols or precede highly important points in the main text. They have the following meanings:

	<p>Read the instructions before you undertake any work.</p>
	<p>Disconnect the mains plug before you carry out any work on the device.</p>

### 1.1.4. Warning signs

Warning signs are attached to different points on the device. They have the following meanings:

	<p><b>Electrical components behind these covers are live.</b>  <b>Risk of an electric shock!</b>          ⇒ Switch off the device and disconnect the power supply before you remove the covers.</p>
	<p><b>General warning</b>          This warning symbol warns against a general source of hazard.</p>
	<p><b>Caution – ESD-protected area</b>          Observe preventive measures when handling components susceptible to damage from electrostatic discharge.</p>
	<p><b>Risk of damage to ESDS. Do not place any electronic components or assembly groups on this surface!</b>          This warning symbol warns against damage to ESDS if they are placed on labeled surfaces.</p>

#### 1.1.5. Conformity, guidelines and directives

The device and its components, modules and assembly groups comply individually and as a whole with the current applicable safety standards as specified in European Union CE Directives (see the enclosed EC Declaration of Conformity).

#### 1.1.6. ESD conformity as per IEC 61340-5-1

The device and its associated components, modules and assembly groups comply individually and as a whole with the requirements specified in IEC 61340-5-1 with regard to work surfaces, storage shelves and transport trolleys (see accompanying ESD certificate of conformity).

#### 1.1.7. Operator

Only trained staff may operate the *C|PS<sup>2</sup> ESD particle suction extraction system*.

More specifically, only staff who have undergone the ESD training stipulated by the owner may operate the *C|PS<sup>2</sup> ESD particle suction extraction system*. The owner must hold refresher training sessions every 24 months.

The manufacturer or persons authorized by the manufacturer to provide training will give training on the device's use.

Persons whose ability to react is impeded by drugs, alcohol, medication or similar must not operate the *C|PS<sup>2</sup> ESD particle suction extraction system*. Region-specific age regulations must be observed.

#### 1.1.8. Obligation and liability

The *C|PS<sup>2</sup> ESD particle suction extraction system* has been built to state-of-the-art standards and in line with established safety regulations. However, using the device may possibly pose a threat to life and physical well-being for the user or third parties or adversely affect the device or other assets.

The device must be used for its designated purpose only.

Any faults which could jeopardize safety must be rectified immediately.

Our General Terms and Conditions of Sale and Delivery apply to the warranty and liability.

### 1.1.9. Obligation to instruct

All persons who work on and with the device and are responsible for the device must read and understand these operating instructions and must comply with all points in the instructions.

**CleanControlling GmbH does not accept any liability or warranty for any damage caused by staff who have received inadequate instructions or who have not received any instructions.**

### 1.1.10. Designated use

The device is used to suction and extract particles in line with the requirements for particle suction extraction.

Any other use other than the one described above is forbidden since improper use could cause a threat to life and physical well-being.



The suction unit or its suction hose may **only** be used in combination with the C|PS<sup>2</sup> ESD particle suction extraction system.

### 1.1.11. Organizational measures and the owner's obligations

The owner must appoint someone who is responsible for the safe operation of the *C|PS<sup>2</sup> ESD particle suction extraction system* and for coordination of all work with the *C|PS<sup>2</sup> ESD particle suction extraction system*.

The owner must appoint an ESD coordinator who is responsible for all ESD aspects related to working with the *C|PS<sup>2</sup> ESD particle suction extraction system* in line with EN 61340-5-1.

The owner must provide the required personal protective equipment. All safety systems must be checked on a regular basis.

The owner must ensure that the *C|PS<sup>2</sup> ESD particle suction extraction system* is inspected on a regular basis to ensure it complies with ESD conformity requirements. The *C|PS<sup>2</sup> ESD particle suction extraction system* needs to be included in the owner's ESD control program plan to ensure this is the case.

Sampling of ESDs with *C|PS<sup>2</sup> ESD particle suction extraction system* is only permitted in suitable, designated ESD-protected areas (EPA).

The owner or the ESD Coordinator is responsible for ensuring correct environmental conditions/rooms.

### 1.1.12. Informal safety measure

The operating instructions must be kept on the device at all times. In addition to the operating instructions, general regulations and other binding regulations on accident prevention and environmental protection must be observed.

You must keep all safety instructions and hazard warnings in a legible condition and replace if necessary.





**1.1.13. Training of staff**

Only trained and briefed staff are permitted to work with and on the device.  
The staff's different responsibilities are specified in the following table:

Task	Briefed technical staff	Specialist
Use/operation	X Also observe Section 1.1.7	
Fault finding	X	
Fault repair		Authorized service technicians
Maintenance	X	
Repair		Authorized service technicians

**1.1.14. Specific hazardous points**

	<p><b>Electrical components behind these covers are live.</b> <b>Risk of an electric shock!</b></p> <p>⇒ Switch off the device and disconnect the power supply before you remove the covers.</p>
	

**1.1.15. Maintenance, servicing and fault repair**

Do not perform work on the device until the device has been disconnected from the mains power supply.

Before putting it back into operation, check that all covers, screw connections and safety systems have been fitted as per regulations and check that they work correctly.

Perform all setting, servicing and inspection work correctly within the required periods.

**1.1.16. Structural changes to the device**

Authorization from the manufacturer is required for any modifications or retrofits.

## Safety

### 1.1.17. Cleaning the device

Correct functioning of the device can only be guaranteed for a longer period of time if the device is kept spotless and is cleaned on a regular basis using customary methods.

Clean with mild, non-scouring, non-scratching products only. Never use aggressive cleaning agents such as solvents.

Handle materials and substances used, such as solvents and lubricants, in a correct, environmentally friendly way.

### 1.1.18. Noise from the device

The sound pressure level from the device can reach up to 75 dB(A).

### 1.1.19. Decommissioning and disposing of the device



This device is labeled in accordance with the European Directive on waste electrical and electronic equipment – WEEE.

You must comply with applicable local regulations on health, safety and the environment at all times when decommissioning the device or disposing of parts of the device.

- You must dispose of the device as electronic waste once its service life has come to an end. Ask your local waste management company or CleanControlling where your particular collection point is.
- Sort different materials such as plastic, metal and electronic components and dispose of them separately.
- Dispose of used liquids safely and correctly, so that they do not cause damage to health or the environment.
- Dispose of all components safely and correctly as per applicable local regulations on health, safety and the environment.

### 1.1.20. Change of owner

Ensure that all components, including spare parts and accessories, are also given to the new owner if you sell the device. These components include all operating instructions, manuals, maintenance instructions, other instructions, modifications and additions that you have received as an owner.

### 1.1.21. Guidelines for a safe work area

- Ensure that work areas and surrounding areas are clean and very tidy and do not contain any potential hazards. The work area must comply with local and national safety regulations.
- There must be enough room around the device to work with the system safely and comfortably and perform adjustment and maintenance work.
- Ensure that cables and hoses are not deformed and cannot be damaged.
- Ensure that the ambient conditions are within the indicated ranges.
- Ensure that no cables or hoses pose a tripping hazard.
- Ensure that the device is only operated in a suitable area (EPA) when used in connection with ESDS.

### 1.2. Defective device

A defective device poses a serious risk of injury for operators and other persons. If the device is not free from defects when in operation and cannot be repaired immediately, the person in charge must switch off the device and put it out of service. The device can be defective if:

- The device shows signs of damage
- Electrical components and wires are damaged
- The device does not perform its required function correctly, even after it has been adjusted
- The device has been stored or not operated for a long time under unfavorable conditions, such as high humidity or excessively high or low temperatures.

### 1.3. Further use of components after suction extraction

- The owner must ensure that components remain undamaged, especially when sampling electronic components that can be damaged or destroyed by electrostatic discharges.
- If the components sampled by the C|PS<sup>2</sup> ESD particle suction extraction system are reused, the owner is responsible for carrying out subsequent tests to ensure their intactness.

## 2. Description

The mobile particle suction extraction system is used to extract dry, adherent particles from large surfaces and from specific control areas on workpiece carriers and in process environments.

The particles are suction-released from the surface by a suction nozzle, brush nozzle, or flat nozzle, and then sucked in.

This compact, combinable system is incorporated into an ESD trolley to protect ESDS. The ESD trolley features a suitable anti-static work surface to ensure easy handling of ESDS.

The ESD trolley provides easy, safe set-up and transportation of the particle suction extraction system and its associated equipment.



Particle suction extraction system – front view

Particle suction extraction is possible **with or without the cyclone unit**. The most suitable process depends on different factors, primarily the specific application and the degree of contamination.

## 2.1. Particle suction extraction system with cyclone unit

The extracted particles are collected in a clean particle collection jar or directly on a particle trap via the cyclone unit (2).

The filter unit (6) provides overload protection using a special analysis filter (> 5  $\mu\text{m}$ ) to protect against an excessively high particle load.

The particles collected in the particle collection jar are transferred to analysis filters for the subsequent microscopic analysis using secondary extraction (with an aqueous medium) and then analyzed under a microscope.

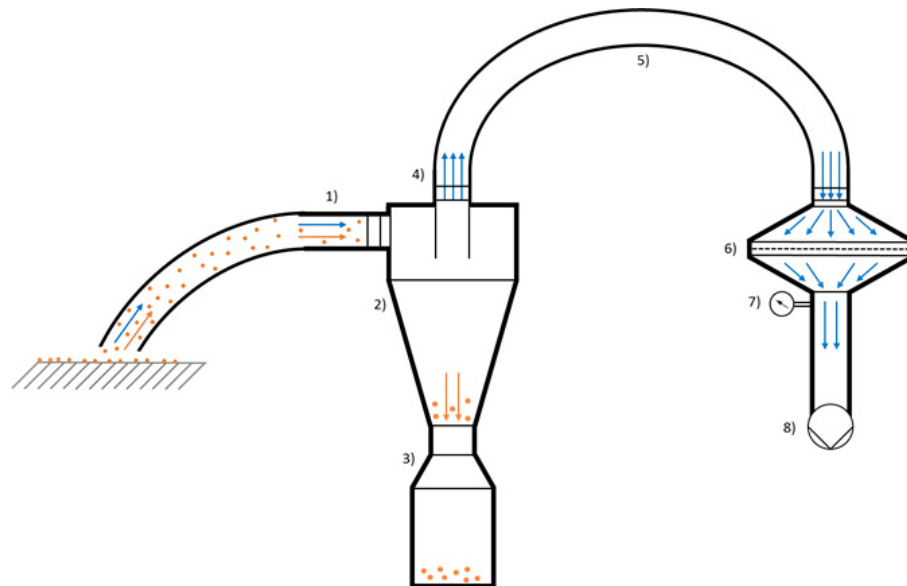

Variant A operating principle: Particle suction extraction system with cyclone unit

Suction extraction via the cyclone unit is particularly suitable for large component surfaces with greater particle loads.

This dry particle extraction system is very economical compared to wet extraction due to the absence of liquid extraction media, the reduced logistics workload and the easily delimited control areas.

## 2.2. Particle suction extraction system without cyclone unit

The particles are extracted directly via the filter unit and separated from the air stream using a special analysis filter ( $>5\mu\text{m}$ ).

The analysis filter can be analyzed using a microscope directly after suction extraction and any downstream flushing.

The flushing unit can be used to prepare particulates on the filter for analysis (see Section 5.4)

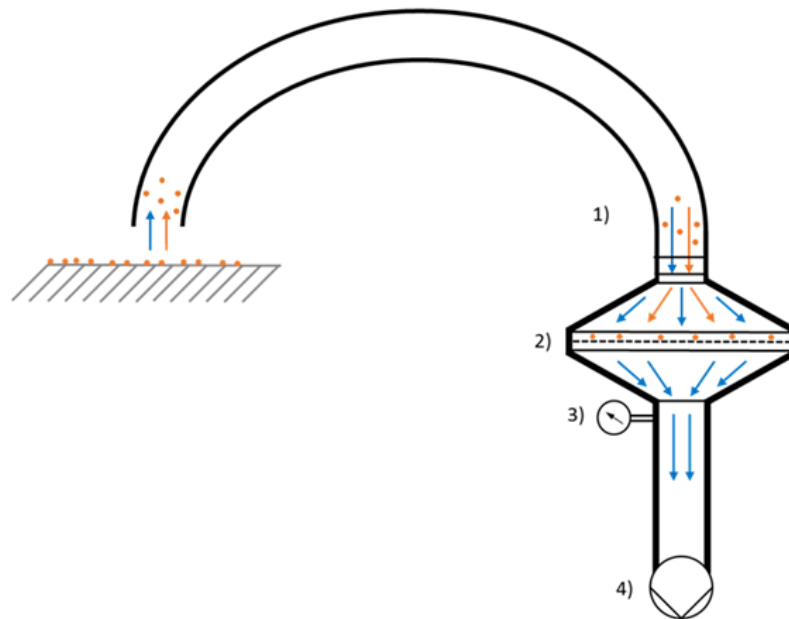

Variant B operating principle: Particle suction extraction system without cyclone unit

Direct suction extraction via the filter unit is suitable for small surfaces with a light particle load, such as on workpiece carriers or printed circuit boards in the process environment.

Particles are quickly collected, meaning interruptions to processes are kept to a minimum.

The specially developed flushing unit allows homogeneous filter loading to be optimized. Manual flushing (see Section 5.4) is performed with an aqueous medium after suction extraction. The analysis filter can be taken for microscopic analysis immediately after drying.

The flushing can also be used as a filter cascade (e.g.  $5\mu\text{m}/60\mu\text{m}$ ) if a higher particle volume is extracted.

### 3. Structure

#### 3.1. Particle suction extraction system (example without flushing unit)

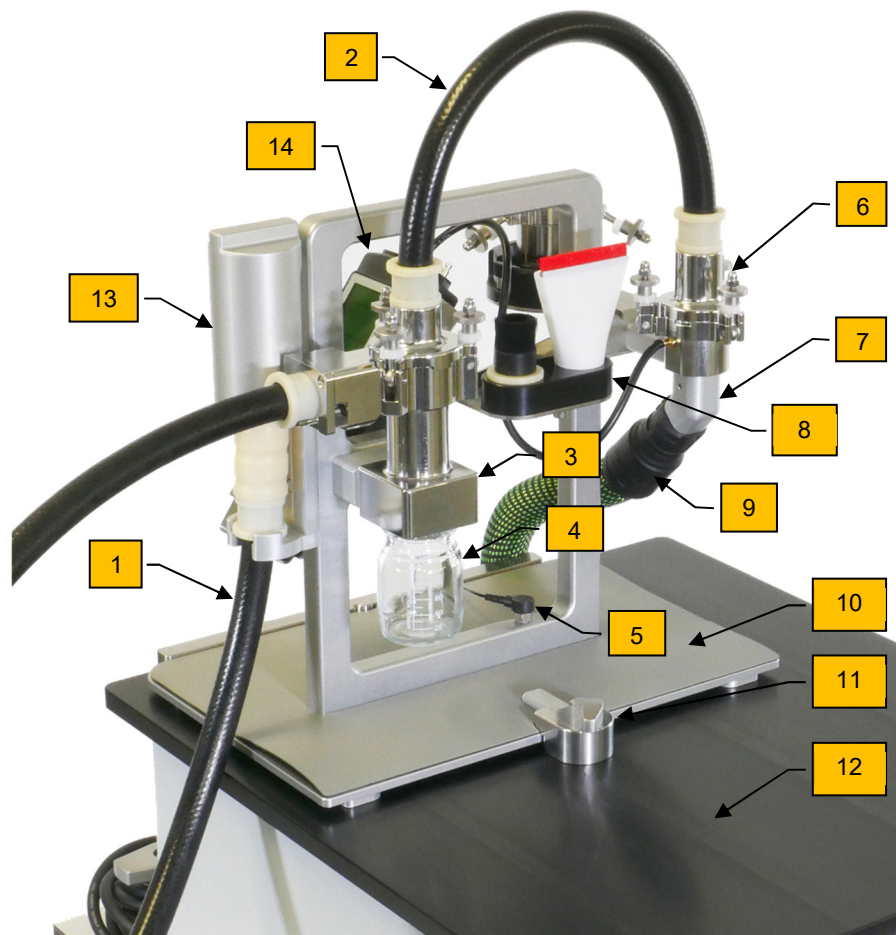

Structure of the particle suction extraction system with cyclone unit

Pos. 1	Suction hose
Pos. 2	Connection hose, 0.5 m
Pos. 3	Cyclone unit
Pos. 4	Particle collection jar
Pos. 5	Grounding connection
	Flushing unit (over the filter unit; not fitted in the photo)
Pos. 6	Filter unit (with measurement connection)
Pos. 7	Connection for suction unit
Pos. 8	Rack for suction and brush nozzles
Pos. 9	Hose to the suction unit
	Remote control – START/STOP for suction (not fitted in the photo)
Pos. 10	Base plate for the C PS <sup>2</sup> system with ESD protective cover
Pos. 11	Anchorage for particle suction extraction system
Pos. 12	Work surface made of anti-static plastic
Pos. 13	Nozzle bracket
Pos. 14	Differential pressure measuring device

Structure

3.2. ESD trolley



ESD trolley structure (front view)

Pos. 10	Base plate for the C PS <sup>2</sup> system with ESD protective cover
Pos. 12	Work surface made of anti-static plastic
Pos. 14	Lever to release the front panel
Pos. 15	4 guide rollers, 2 with parking brakes
Pos. 16	Front flap
Pos. 17	Drawer section for analysis and extraction equipment
Pos. 18	Locking mechanism for the C PS <sup>2</sup> system base plate



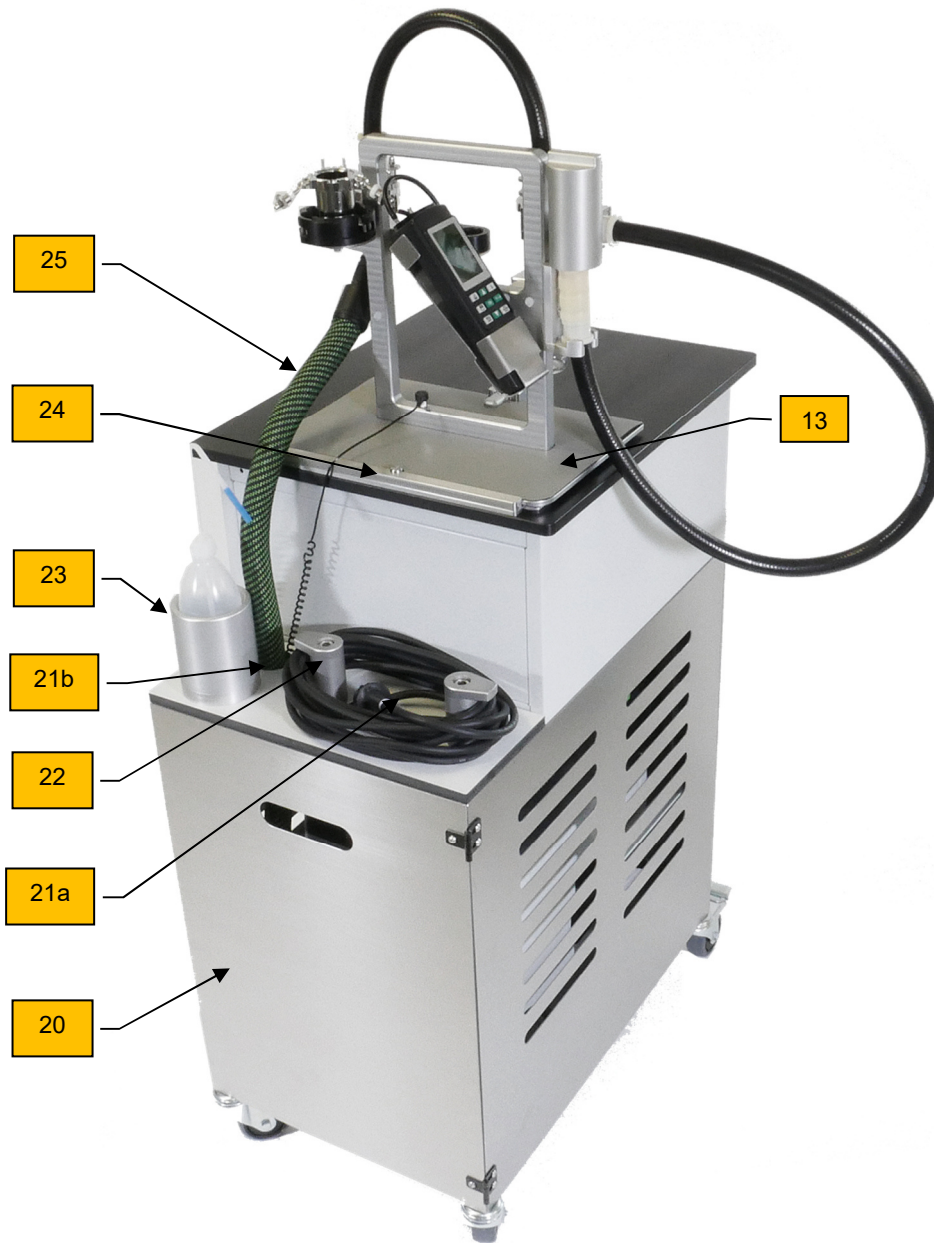

ESD trolley structure (rear view)

Pos. 10	Base plate for the C PS <sup>2</sup> system with ESD protective cover
Pos. 20	Service doors for the suction unit
Pos. 21a	Outlet for the mobile extractor's power cable
Pos. 21b	Outlet for the mobile extractor's suction hose and grounding cable
Pos. 22	Cable holder for the mobile extractor's power cable
Pos. 23	Holder for laboratory washing bottle
Pos. 24	Stop ledge for the C PS <sup>2</sup> system base plate
Pos. 25	Mobile extractor's suction hose

#### 4. Initial operation

**NOTE**



Wrap the sampled ESDS in ESD-protected packaging while carrying out work on the C|PS<sup>2</sup> system or remove the C|PS<sup>2</sup> system from the EPA environment to prevent any damage to the ESDS.

The C|PS<sup>2</sup> ESD particle suction extraction system is put into operation by following the steps below



Open front flap

⇒ Hold front flap (16) using the handle opening, press the lever (14) to unlock the front flap and open front flap (16).

**CAUTION**

**Risk of injury**

Always hold front flap using the handle opening when opening and closing it; otherwise, you may crush your fingers if the front flap slams down.



Preparing suction unit 1



Preparing suction unit 2

- ⇒ Open the suction unit flap (26) and feed around 1.5 m of the suction hose (27) through the hole (28) designated for this purpose and close and lock the flap (26) again.
- ⇒ Unwind the suction unit power cable (28) and place on the flap (26).



Pushing the suction unit into the ESD trolley

⇒ Position suction unit (26) on the open front flap (16) as shown in the photo and push into the ESD trolley.



Connecting the grounding cable

- ⇒ Prop up the suction unit. To do so, press down the black support (30) and let it lock into position.
- ⇒ Plug the supplied grounding cable (31) into the suction unit socket.
- ⇒ Place the spiral cable (32) with the grounding cable push button adapter on the power cable (28) and close the front flap.



Opening the service door

⇒ Open service doors (20) on the ESD trolley rear.



**Pulling the power cable through**

⇒ Pull the power cable (28) through the ESD trolley's outlet opening (21a) completely.



Winding the cable

- ⇒ Wind power cable (21) around its holder (22).
- ⇒ Also pull the grounding cable (32) through ESD trolley's outlet opening (21b).





**Feeding the suction hose through**

- ⇒ Feed the suction hose (27) through outlet opening.
- ⇒ Close service doors on the ESD trolley rear.



Releasing the anchorage

⇒ Release the C|PS<sup>2</sup> system locking mechanism on the ESD trolley by unscrewing the wing nut (32). Undo wing nut completely.



Lifting out the C|PS<sup>2</sup>

⇒ Open the transport case locking mechanism (33) and lid (34).  
⇒ Carefully lift the C|PS<sup>2</sup> system out of the transport case...

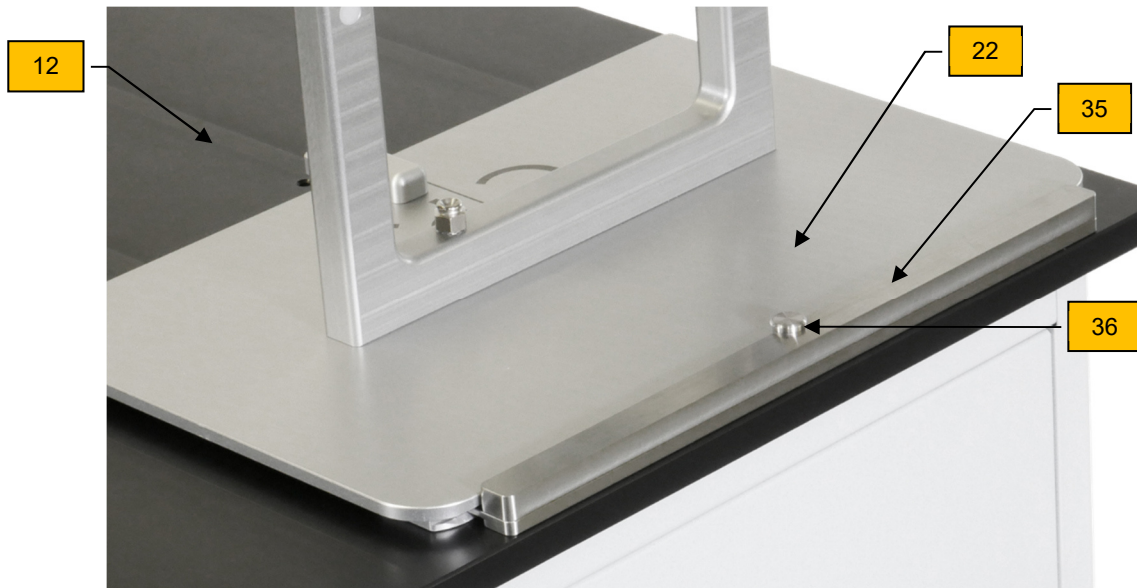

Setting up the C|PS² system

⇒ and place it on the ESD trolley work surface (12) so that the base plate (12) rests against the stop rail (35) and the notch in the base plate (12) fits precisely around the retaining bolt (36) on the stop rail.

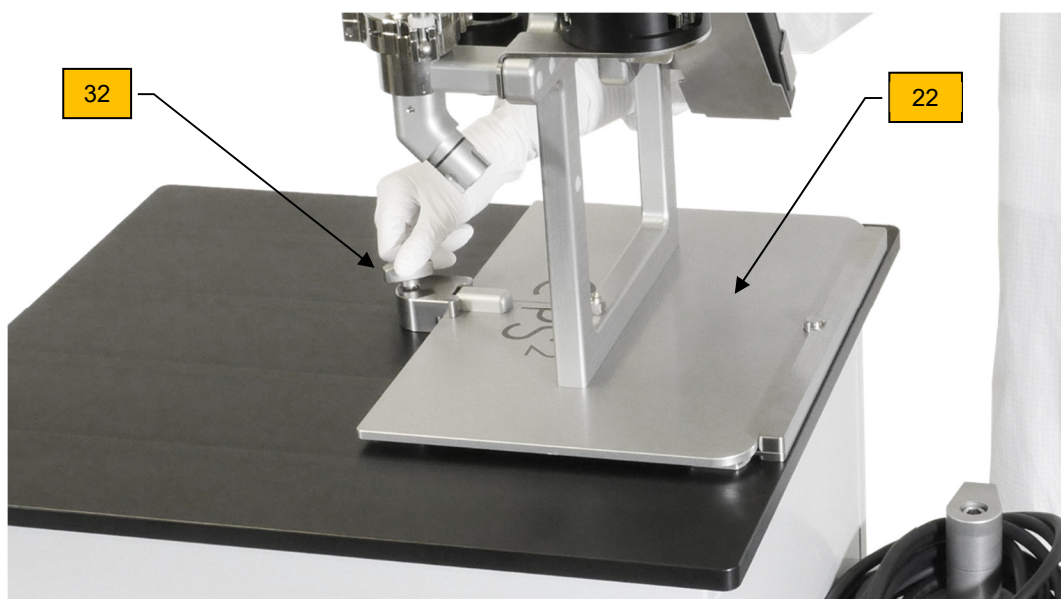

Securing the C|PS² system

⇒ Place the C|PS² system's locking mechanism against the base plate (22) and fasten the wing nut (32) to secure the C|PS² system in place.

**⚠ CAUTION**

**Risk of injury or damage to the device**

To prevent the C|PS² from falling off, always ensure that the base plate (22) rests correctly against the stop rail (35), the retaining bolt (36) fits into the notch in the base plate (22) and the locking mechanism wing nut (32) is firmly tightened.

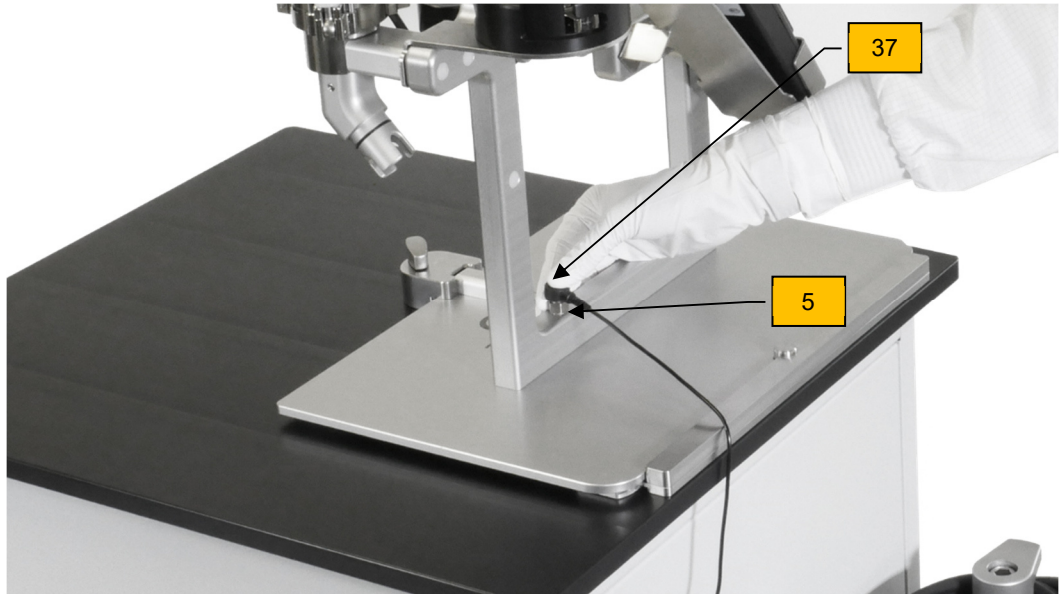

Connecting the grounding cable

⇒ Plug the push button adapter (37) on the grounding cable from the suction unit socket into the C|PS<sup>2</sup> system's grounding connection (5).

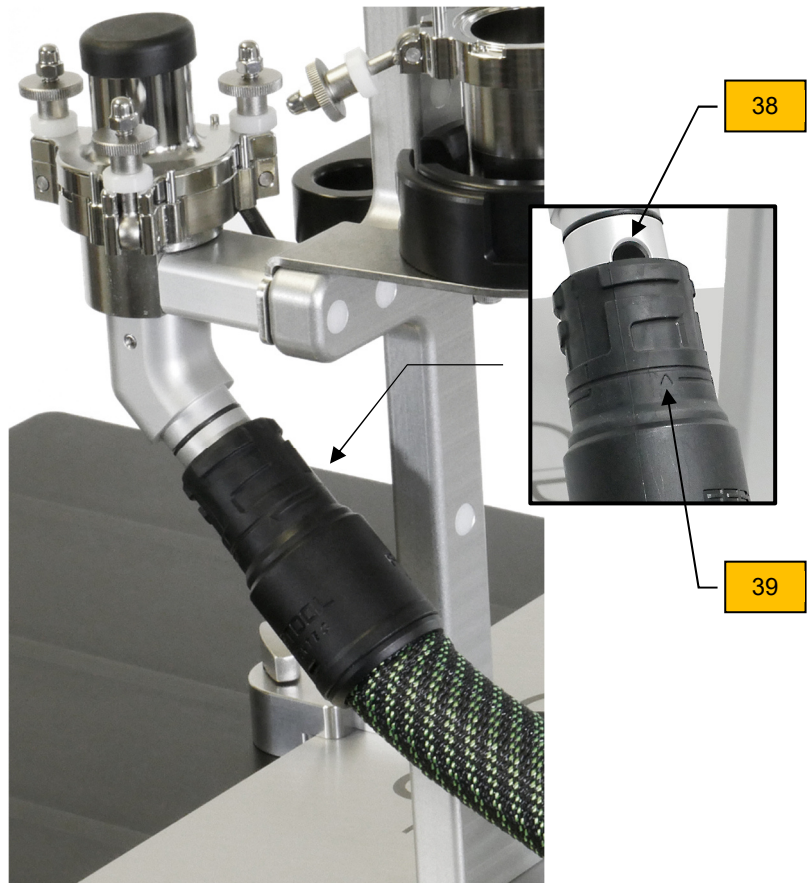

Attaching the suction unit connection hose

⇒ Attach the connection hose to the suction unit on the C|PS<sup>2</sup>. When you do so, the arrow (39) on the connection hose must face the hose connection slot (38).

#### 4.1. Initial operation



The photos used here as an example show the procedure on the C|PS2 system **without the ESD trolley** to a certain extent. It is explicitly pointed out where the systems differ.



Interconnecting cyclone unit and filter unit

⇒ Remove the protective cap and interconnect the cyclone unit and the filter unit with the 0.5 m connection hose.



Insert connection hose until it locks into position and check that it is correctly positioned before use.



Suction extraction with the cyclone unit can also be performed without the flushing unit shown in the photo above.



You will also find information on putting the particle suction extraction system C|PS<sup>2</sup> into operation with the cyclone unit and can see the precise procedure in our application video at: <https://bit.ly/3aoSWG9>





Attaching the suction hose (1 or 2 m)

⇒ After removing the protection plug, connect the suction hose to the cyclone unit. To do so, move the lock lever (32) upwards and insert the suction hose until the lock lever (32) moves downwards again to attach the hose.



Attaching the suction nozzle

⇒ Attach the required suction nozzle (9) suitable for the intended particle suction extraction process.



Attach or insert the suction hose and suction nozzle until they lock into position.

#### 4.2. Initial operation without cyclone unit



Attaching the suction hose and suction nozzle

- ⇒ After removing the cover cap, connect the suction hose (1) to the flushing unit (5). To do so, insert suction hose (1) into the flushing unit (5) from above until it locks into position.
- ⇒ Attach the required suction nozzle (9) suitable for the intended particle suction extraction process.



Suction extraction unit can also be performed without the flushing unit shown in the photo above.



You will also find information on putting the particle suction extraction system C|PS² into operation without the cyclone unit and can see the precise procedure in our application video at: <https://bit.ly/3aoSWG9>



### 4.3. Connecting the remote control and suction unit

To be able to connect a remote control to a suction unit, it may be necessary to reset the remote control (see chapter 4.4 Resetting the remote control or original operating instructions Festool – mobile dust extractors).

Remote controls that have not yet been connected can be connected directly.



A connection that has been created between remote controls and the suction unit will persist even after the suction unit has been manually switched off or the mains plug has been disconnected.



The suction unit can be connected to as many as five remote controls at the same time. However, a remote control can be connected to only one suction unit.

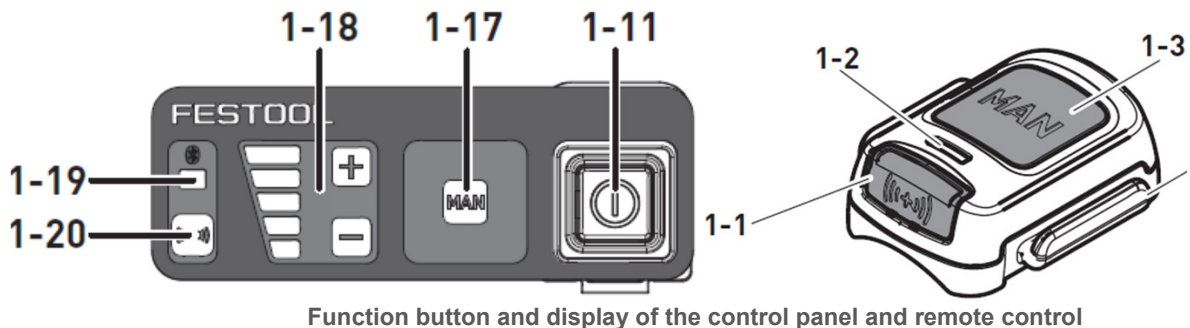

The following steps must be followed to connect a remote control that has not yet been connected (or after a reset has been performed) to the suction unit:

- ⇒ In stand-by mode, press and hold the connection button **[1-20]** of the suction unit for 3 seconds.
- ⇒ The connection display **[1-19]** flashes rapidly. For a period of 60 seconds, suction unit is ready for connection.
- ⇒ Press the MAN button **[1-3]** on the remote control.
- ⇒ The remote control is permanently stored in the suction unit.

Once the remote control is connected to the suction unit, the suction unit can be switched on and off with the remote control.

- ⇒ Press the MAN button **[1-3]** on the remote control to switch the device on and off.

### 4.4. Resetting the remote control

Resetting deletes the connection between a remote control and the suction unit.

- ⇒ Hold down the connection button **[1-1]** and the MAN button **[1-3]** for 10 seconds.
- ⇒ The LED indicator **[1-2]** lights up purple if the reset has taken place.



#### 4.5. Deleting all stored Bluetooth connections of the suction unit

If necessary, all stored device connections can be deleted with the following steps:

- ⇒ Press and hold the connection button **[1-20]** for at least three seconds.
- ⇒ The connection display **[1-19]** flashes rapidly.
- ⇒ Release the connection button **[1-20]** again.
- ⇒ Within 3 seconds, press and hold the Plus and Minus button **[1-18]** simultaneously for at least 3 seconds.
- ⇒ The suction unit confirms the command by rapidly flashing three times **[1-19]**.



Before a remote control can be reconnected to the suction unit, which was previously connected to this or another suction unit, the remote control should be reset.

## 5. Particle suction extraction process

**NOTE**



Wrap the sampled ESDS in ESD-protected packaging while carrying out work on the C|PS<sup>2</sup> system or remove the C|PS<sup>2</sup> system from the EPA environment to prevent any damage to the ESDS.

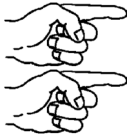

The extraction process shown here is performed **with the cyclone unit** and is also valid for an extraction process without a cyclone unit. If necessary, the device must be cleaned and a blank value determined before particle suction extraction – see Section 6.2 for more details.

### 5.1. Screwing on or replacing the particle collection jar

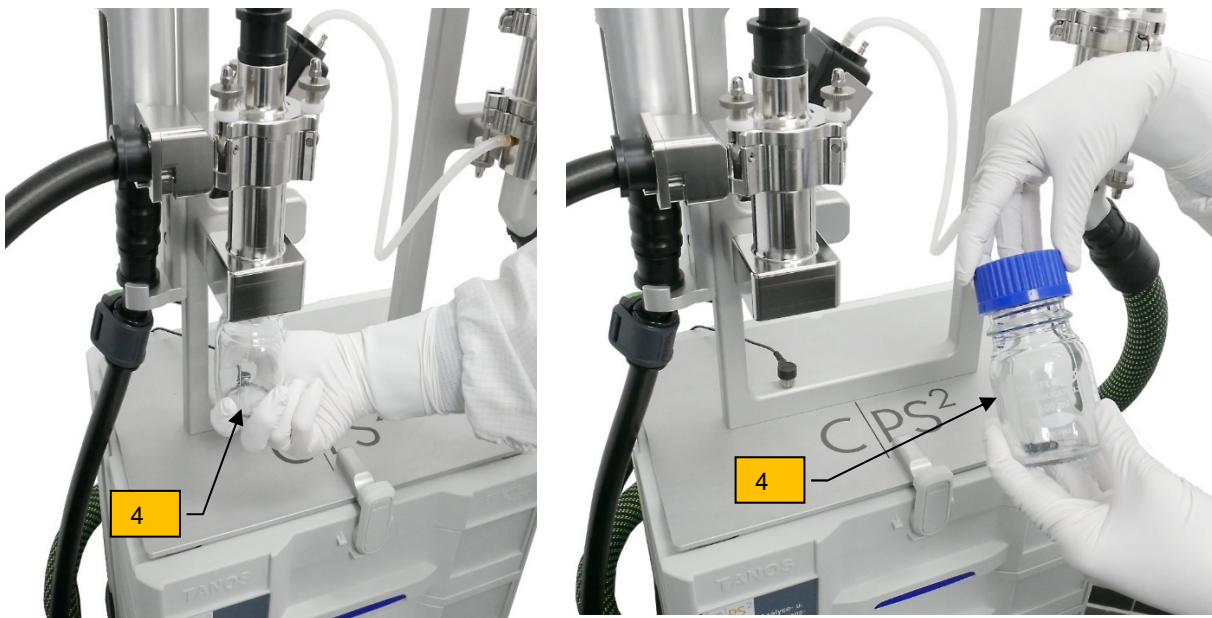

Replacing the particle collection jar

- ⇒ Screw on a new, clean particle collection jar (4) into the cyclone unit from beneath.
- ⇒ Once particle suction extraction is complete, unscrew the particle collection jar (4) to be analyzed, close with the lid and label with the relevant sample details.
- ⇒ Use secondary extraction (with an aqueous medium) to transfer the particles collected in the particle collection jar (4) onto the analysis filter for the subsequent microscopic analysis and then analyze under a microscope.

## 5.2. Attaching or replacing the particle trap

**NOTE**



Wrap the sampled ESDS in ESD-protected packaging while carrying out work on the C|PS<sup>2</sup> system or remove the C|PS<sup>2</sup> system from the EPA environment to prevent any damage to the ESDS.

The cyclone unit can also extract directly onto the particle trap if contamination is less severe



Attaching the particle trap

- ⇒ If necessary, unscrew particle collection jar and screw on adapter (13) for the particle trap.
- ⇒ Attach particle trap (14) to the adapter (13).
- ⇒ After extraction, detach particle trap (14) by pulling downwards, close with the lid, and label with the relevant sample details.
- ⇒ Then analyze the particle trap under a microscope.

### 5.3. Replacing or inserting the mesh filter

**NOTE**



Wrap the sampled ESDS in ESD-protected packaging while carrying out work on the C|PS<sup>2</sup> system or remove the C|PS<sup>2</sup> system from the EPA environment to prevent any damage to the ESDS.

A filter unit is provided as a safeguard and overload protection in case any particles not separated in the cyclone unit are still forwarded. The cyclone unit overload protection is necessary if there are very large, fitful extraction volumes of particles.

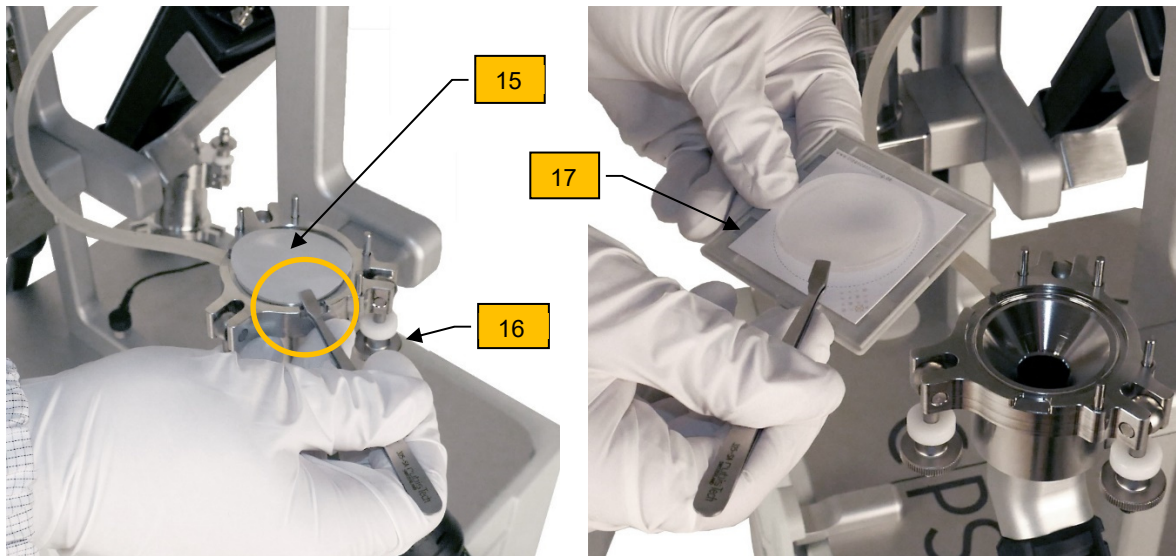

Removing and archiving the mesh filter

- ⇒ Open filter unit after undoing and swiveling away the three knurled screws (16)
- ⇒ Use the tweezers to remove the mesh filter (15). To do so, attach the tweezers in the designated hole (circled) in the filter unit and remove the mesh filter.
  - ⇒ Archive the mesh filter in a filter frame with an archiving card (17) and label with the relevant sample details on the rear.
- ⇒ Then analyze the mesh filter with a microscope (as per ISO 16232). The particles on the mesh filter removed from the filter unit complement the microscopic analysis.
- ⇒ Insert the new mesh filter (15) into the filter clamping point.
- ⇒ Remount filter unit, ensuring the mesh filter (15) is positioned correctly and tighten with the knurled screws (16).



If particle suction extraction is performed without a cyclone unit, analysis is carried out based on the mesh filter evaluation only.

#### 5.4. Flushing the mesh filter

**NOTE**



Wrap the sampled ESDS in ESD-protected packaging while carrying out work on the C|PS<sup>2</sup> system or remove the C|PS<sup>2</sup> system from the EPA environment to prevent any damage to the ESDS.

The specially developed flushing unit allows homogeneous filter loading to be optimized. Manual flushing is performed with an aqueous medium after suction extraction. The analysis filter can be taken for microscopic analysis immediately after drying.

The flushing can also be used as a filter cascade (e.g. 5 µm/60 µm) if a higher particle volume is extracted.

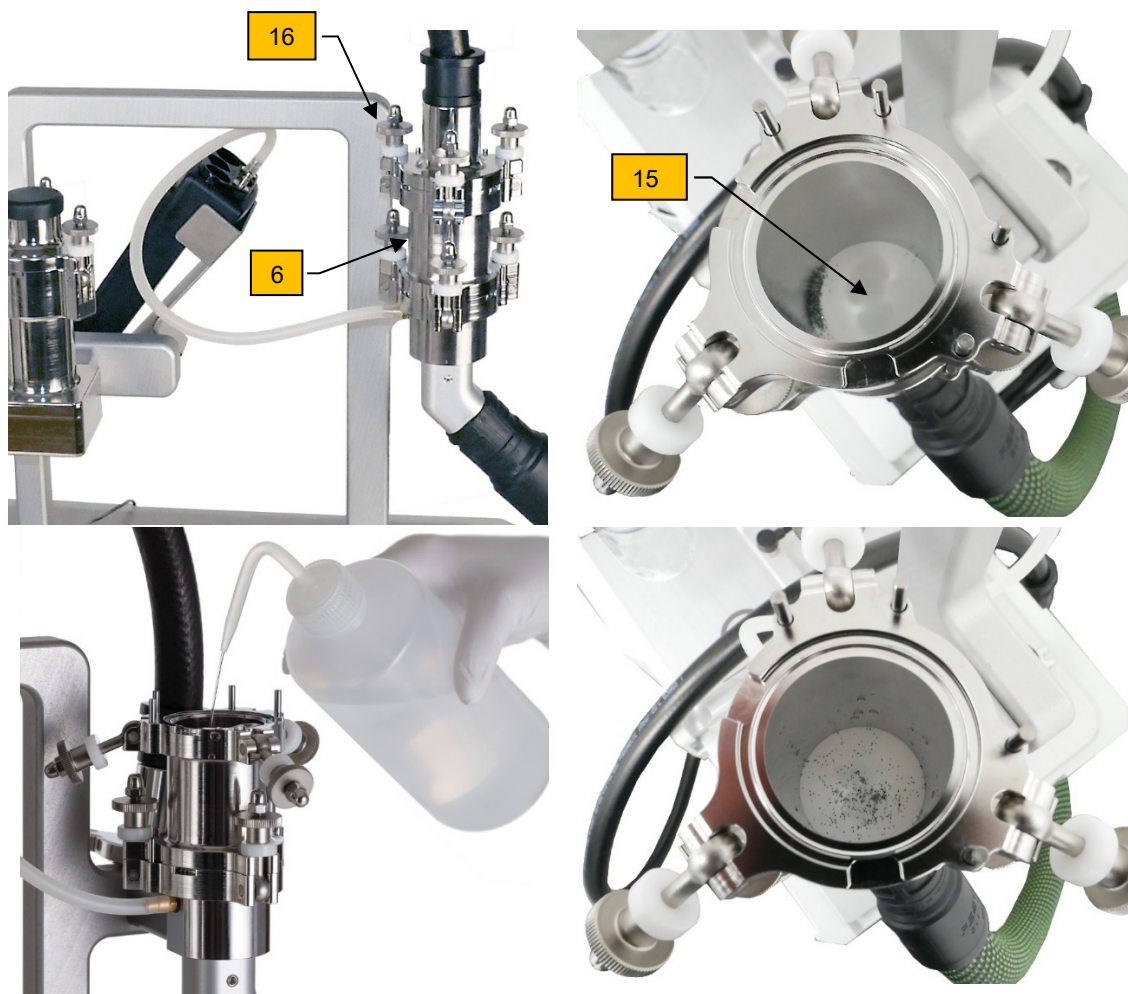

Flushing to optimize particle distribution

- ⇒ Open flushing unit (6) after undoing and swiveling away the three knurled screws (16).
- ⇒ If the mesh filter (15) features inhomogeneous particle distribution, spread the particles uniformly across the mesh filter (15) by flushing with an aqueous medium and then suction.  
To do so, an aqueous film or liquid column is created with the aqueous medium, in which the particles are diffusely distributed. The particles are fixed in their current position on the filter after sudden suction in the aqueous medium.
- ⇒ Then remove and analyze the mesh filter as described in Section 5.3.



**Do not set the suction unit to the operating point (OP) for flushing; set it to its lowest level instead** – see Section 5.5 for more details.



Setting the suction unit to the lowest level

### 5.5. Setting and switching on the suction unit

**NOTE**



Wrap the sampled ESDs in ESD-protected packaging while carrying out work on the C|PS<sup>2</sup> system or remove the C|PS<sup>2</sup> system from the EPA environment to prevent any damage to the ESDs.

The remote control (B) is electrostatically chargeable and should not be attached to the suction hose. A suitable location must be determined by the operator or other protective measures must be taken.

⇒ Open the front flap on the ESD trolley as described in Section 4.1.

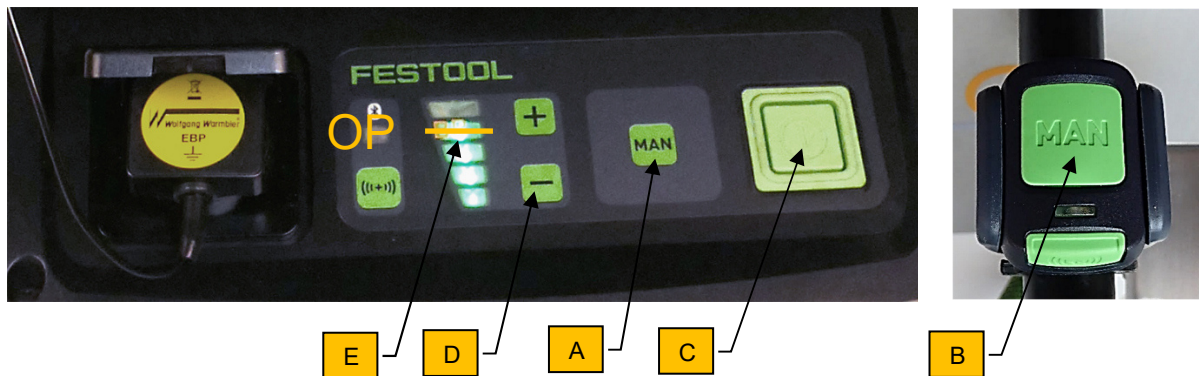

Setting the suction unit to the operating point (OP)

- ⇒ Before starting, switch on the suction unit at the I/O switch (C). Set the operating point (OP) using the +/- keys (D) where necessary. Suction level indicator (E) at OP mark, as shown in the photo.
- ⇒ The suction unit can be started manually on the vacuum extractor touch panel (A) or on the suction hose using Bluetooth remote control (B).

**NOTE**

Operating above the operating point (BP) may cause a reduction in the available suction time (due to thermal shutdown on the vacuum extractor unit).

Operating below the OP will have an adverse effect on the filtration rate during filtration via the cyclone unit.

## 5.6. Carrying out the particle suction extraction procedure

**NOTE**



You must ensure correct electrical connection, especially for the C|PS<sup>2</sup> system grounding system, at all times during sampling.

The workstation must be free from any materials containing:

- Nonconductive plastics
- Polystyrene foam
- Unsuitable protective covers and folders



Extracting particles

- ⇒ Turn nozzle bracket (11) to open it and remove the suction nozzle.
- ⇒ Extract the particles with the selected suction nozzle – e.g. with brush nozzle (9) as in the photo.
- ⇒ Insert the suction nozzle into the nozzle bracket after use and turn the nozzle bracket to close.

**NOTE**

The filter load affects the suction power significantly. The mesh filter becomes blocked if the suction power is inadequate. This is revealed by a rise in differential pressure, which the differential pressure measuring device can monitor.

**NOTE**

Only use the mesh filter specified in the scope of delivery! Other types of filters can cause malfunctions.

## Particle suction extraction process



During suction extraction, ensure that you take samples from components or surfaces from the outside to the inside and from top to bottom.



A vacuum must be applied for about 30 sec. after suction extraction and before each change of a nozzle variant (including removing the particles from the brush attachments) to ensure that all particles extracted from the component can be found in the analysis. You can do this by holding the suction hose with the respective nozzle attachment in the atmosphere while the suction unit is active.



You will also find information on the particle suction extraction process with or without the cyclone unit and can see the precise procedure in our application video at: <https://bit.ly/3aoSWG9>



With cyclone unit



Without cyclone unit



## 5.7. Instructions on using the suction and brush nozzles

### Suction nozzle

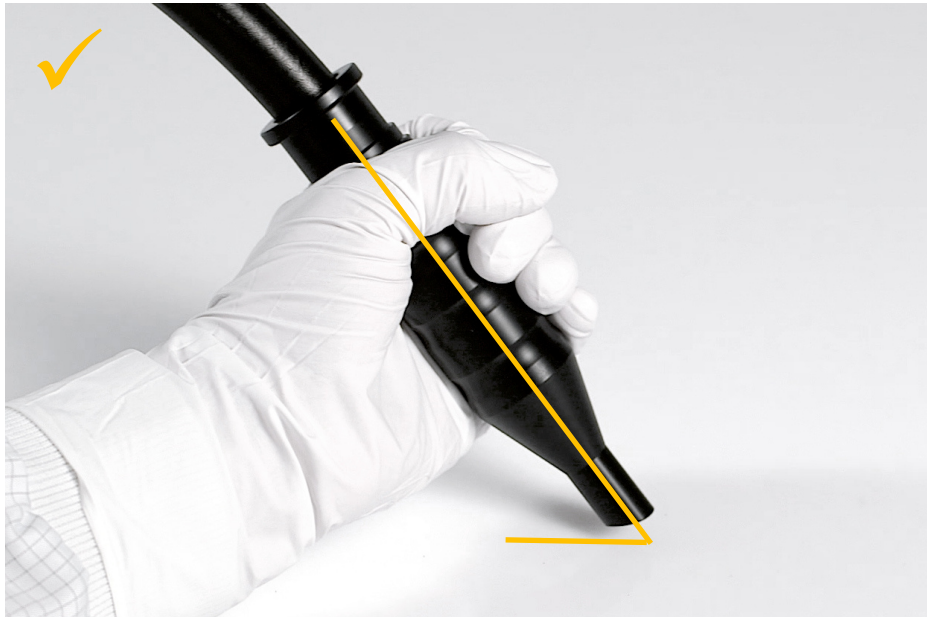

Correct distance and angle to hold the suction nozzle



Incorrect distance and angle to hold the suction nozzle

- When using the suction nozzle or flat nozzle, ensure that you don't block the nozzle by closing the suction nozzle head. Holding the nozzle at an angle ensures adequate suction power is achieved (optimal at a degree of about 35°–40°).
- If you apply the nozzle with strong contact pressure, it may leave marks or generate particles on the surface undergoing extraction.

### Brush nozzle



Applying the brush nozzle correctly



Applying the brush nozzle incorrectly

- When using the brush nozzle, ensure that the brush nozzle is not applied at an angle.
- The contact pressure should not cause the brush hairs to bend. You should aim to apply the brush nozzle at a right angle.

### Flat nozzle

**NOTE**



The flat nozzle is made of plastic that is not suitable for testing ESDS. When used with regard to ESDS, suitable protective measures (e.g. antistatic spray) must be taken and approved by the operator.

The flat nozzle is not included in the standard scope of delivery of the CJPS<sup>2</sup> ESD.



Applying the flat nozzle correctly



Applying the flat nozzle incorrectly

- When using the flat nozzle, ensure that the contact pressure does not cause the brush hairs to bend.
- You should aim to guide the flat nozzle with your hand parallel to the component surface.



You will also find information on selecting the nozzle and can see the precise procedure in our application video at: <https://bit.ly/3aoSWG9>



### 5.8. Differential pressure measurement

The testo 526-1 measurement device is used to gauge the pressure in the system after the mesh filter in relation to the ambient pressure during particle suction extraction. The pressure difference is an indicator for the reproducibility of the selected process parameters.



The following guide values are given when using the vacuum cleaner unit, 5 µm mesh filter and the marked operating point:

<b>Differential pressure with a 1 m suction hose</b>	
Usage	<b>CYCLONE and FILTER UNIT</b>
Suction nozzle/flat nozzle	170 mbar +/- 10 mbar
Brush nozzle	170 mbar +/- 10 mbar
	<b>FILTER UNIT</b>
Suction nozzle/flat nozzle	170 mbar +/- 10 mbar
Brush nozzle	170 mbar +/- 10 mbar

<b>Differential pressure with a 2 m suction hose</b>	
Usage	<b>CYCLONE and FILTER UNIT</b>
Suction nozzle/flat nozzle	175 mbar +/- 10 mbar
Brush nozzle	175 mbar +/- 10 mbar
	<b>FILTER UNIT</b>
Suction nozzle/flat nozzle	170 mbar +/- 10 mbar
Brush nozzle	170 mbar +/- 10 mbar

### 5.8.1. Connection of the differential pressure measuring device

**NOTE**



The differential pressure measuring device is not grounded and therefore needs to be in its designated holder at all times. It must not be placed in the EPA area.

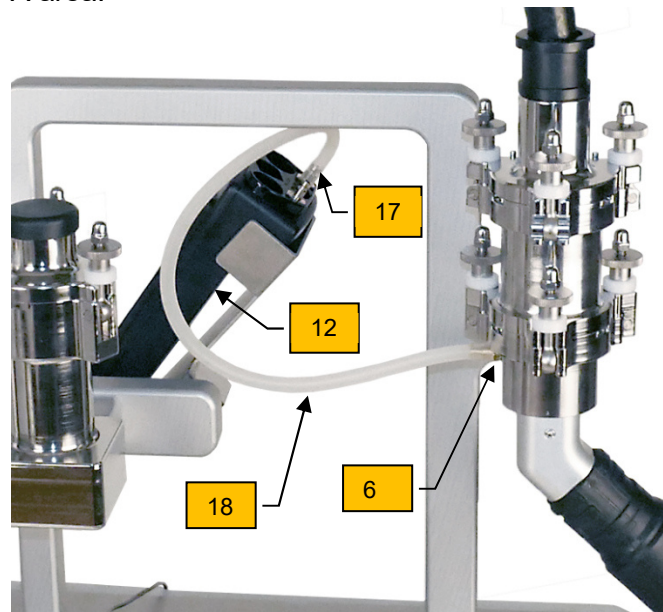

Connection of the differential pressure measuring device

- ⇒ The differential pressure measuring device (12) features two connection options: (+) and (-). To perform measurement, insert the compressed air hose (18) onto the (-) connection (17) and connect with the measurement connection on the filter unit (6).

### 5.8.2. Setting the differential pressure measuring device

#### NOTE



The differential pressure measuring device is not grounded and therefore needs to be in its designated holder at all times. It must not be placed in the EPA area.



The differential pressure measuring device

- ⇒ Switch on the differential pressure measuring device testo 526-1 **I/O**.
- ⇒ Before starting measurement, press **OK** on the main menu and use the arrow keys to navigate to the "Memory" option. Use arrow keys to select the "Man/Auto" sub-item and press **OK** to confirm. Use arrow keys to select "Auto" and press **OK** to confirm. Press **ESC** to return to the measurement screen.
- ⇒ You can select the measurement interval under "Memory" in the main menu: Press **OK** on the main menu and use the arrow keys to navigate to the "Memory" option. Use arrow keys to select the "Config." sub-item and press **OK** to confirm. Use the arrow keys to set the measurement rate in *h*, *min* and *sec* and press **OK** to confirm. Use the arrow key to set the number of measurements and press **OK** to confirm. Press **ESC** to return to the measurement screen.
- ⇒ Press the **⏏** key to start and stop measurement.  
The **⏏** symbol on the measurement screen flashes when measurement is being taken.  
The measurement process stops automatically after the specified time. The user determines the measurement interval. Measurements are saved to the memory as a log.
- ⇒ To delete logs, press **OK** to access the menu → select "Memory" → **OK** → select "Delete" → **OK** → **OK**. You can press **ESC** to interrupt the process.



All logs are always deleted.

### 5.8.3. Using the timer

**NOTE**

The timer is not grounded and therefore must not be placed in the EPA area.



The timer

The timer is used to control time-dependent processes, such as determining the blank value, during particle suction extraction measurement.

- ⇒ Press **MINUTE** and **SECOND** to select the timer interval.
- ⇒ **START/STOP** starts and interrupts the countdown.

An audible warning signal sounds once the countdown has come to an end.

Additional functions:

- ⇒ You can reset the countdown by pressing **MINUTE** and **SECOND** at the same time.
- ⇒ Press **START/STOP** at 00:00 to start the count-up timer.

## 6. Cleaning

### 6.1. Cleaning equipment and carrying out thorough cleaning

**NOTE**



As parts of the C|PS<sup>2</sup> system may become statically charged during cleaning tasks, all cleaning work must be carried out in a suitable place outside the EPA area.



Clean the particle suction extraction system thoroughly before initial operation and between individual measurements. Particles from previous tests or contaminants may distort the analysis results. For this reason, it is important to remove all remaining particles from the system as far as possible.

It is recommended to use a number of fresh, alcohol-soaked cleaning cloths per cleaning process, depending on how contaminated the appliance is, to clean the device thoroughly to an optimum extent.

#### 6.1.1. Preparing cleaning equipment and cleaning



Cleaning wire assembled

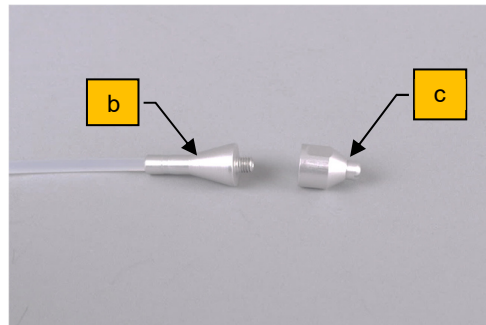

Cleaning wire disassembled

⇒ Clean the suction hose (Pos.1) or the connection hose (Pos. 2) with the cleaning wire (a). The cleaning wire head piece comprises the cleaning wire lower section (b) and the cone (c).



Damp, alcohol-soaked cleaning cloths prevent the wire from sticking. Do not use dried-out cleaning cloths.

The folded corner of the alcohol-soaked cleaning cloth will tear off if you press or pull on the cleaning wire strongly.

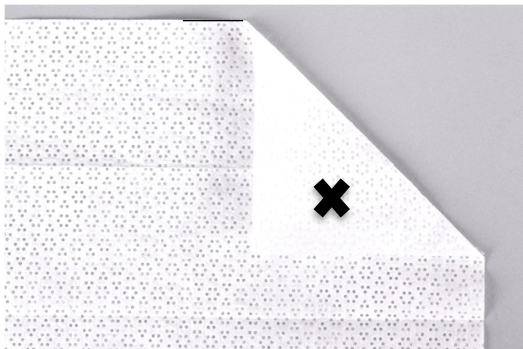

Attachment point for the alcohol-soaked cleaning cloth



Inserting through the attachment point

⇒ Unscrew the cleaning wire (a) cone (c) and wrap or fold over the



alcohol-soaked cleaning cloth about 6.5 cm at one corner (see photo). Punch a hole in the folded corner with the thread of the cleaning wire lower section (b) (see the x in the photo).

- ⇒ Do not make the hole too big (as large as the diameter of the thread as a maximum); otherwise, you will not be able to fasten it with the cone (c).



Cleaning wire with attached alcohol-soaked cleaning cloth

- ⇒ Screw on the cone (c) to attach the folded, alcohol-soaked cleaning cloth.

### Disassembly and cleaning

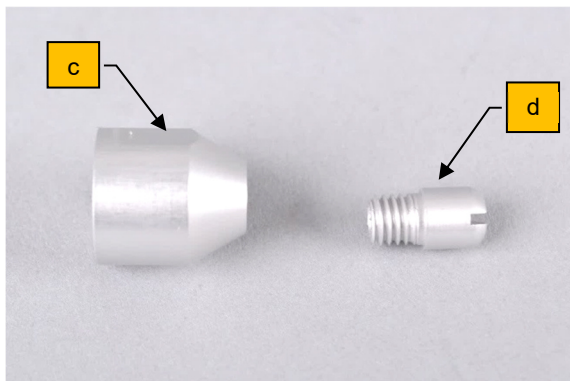

Cleaning wire cone with screw

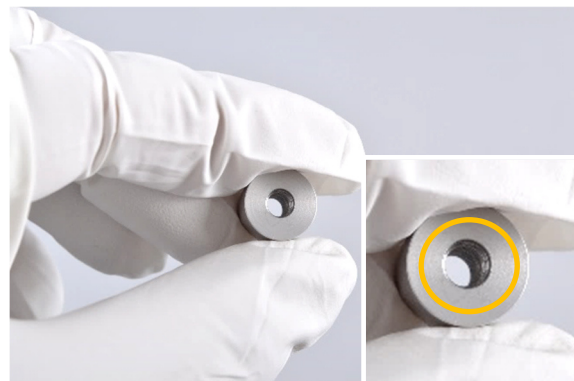

Thread to be cleaned

- ⇒ You can disassemble the cone (c) by hand, using a screwdriver and open-end spanner if necessary.



Blocked cone thread



Removing cleaning cloth remains

- ⇒ The cleaning wire cone features a small screw (d). You can remove the screw (d) to clean the cone thread with a pointed

object. Bits of alcohol-soaked cleaning cloths will stick in the thread and occasionally need to be removed.

### 6.1.2. Cleaning hoses



Inserting the alcohol-soaked cleaning cloth



Alcohol-soaked cleaning cloth pushed through



Alcohol-soaked cleaning cloth inverted 180°



Feeding the alcohol-soaked cleaning cloth back through

- ⇒ Carefully feed the alcohol-soaked cleaning cloth through the hose with the help of the cleaning wire (a). Do not compress the cleaning cloth at a single point; otherwise, it is in danger of getting stuck. You can prevent this by carefully feeding and turning the cleaning cloth into the hose being cleaned. After feeding it through the entire hose, turn the cleaning cloth around 180° and carefully pull the cleaning wire back through with the cleaning cloth.



You will also find information on cleaning the particle suction extraction system C|PS<sup>2</sup> into operation and can see the precise procedure in our application video at: <https://bit.ly/3aoSWG9>





Cleaning the connectors on the end of the hose

⇒ Also clean the ends of hoses with their connectors with the alcohol-soaked cleaning cloth.



Clean all hoses in the way described.



If the cleaning cloth gets stuck in the hose, flush the hose with demineralized water to remove the cloth. Then clean the hose again.



Cover hose ends with plugs



Hose ends with plugs

⇒ Once the hoses have been cleaned, insert the hose ends into their designated positions on the particle suction extraction system. If you no longer intend to use the hose after thorough cleaning, close it with a plug to prevent it from becoming contaminated with particles.

### 6.1.3. Cleaning the nozzles



Pre-cleaning the brush suction nozzle mechanically

- ⇒ Loosen and suction particles from the bristles on the brush suction nozzle and the flat nozzle by wiping while the suction unit is switched on.
- ⇒ Use an ultrasonic bath with water and commercial dish-washing detergent to clean the brush. Then rinse the brush and leave to dry.



Brush nozzle hand piece



Cleaning the suction nozzle

- ⇒ Clean the suction nozzle or the brush nozzle hand piece with a cleaning tab and an alcohol-soaked cleaning cloth.

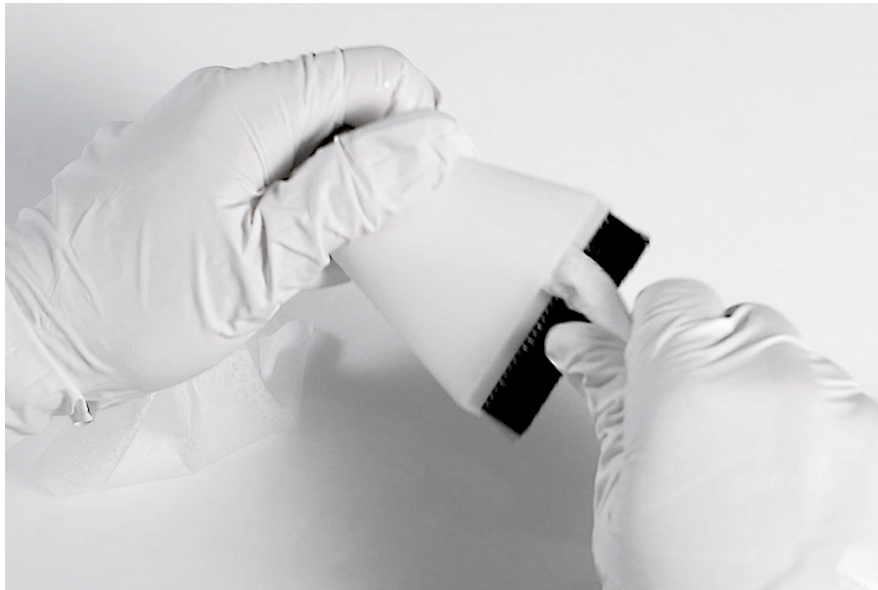

Cleaning the flat nozzle on the inside



... and outside

⇒ Clean the brush and flat nozzles and their bristles on the inside and outside with an alcohol-soaked cleaning cloth.

Cleaning

6.1.4. Cleaning the system

⇒ Clean all parts using an alcohol-soaked cleaning cloth and the cleaning tab.

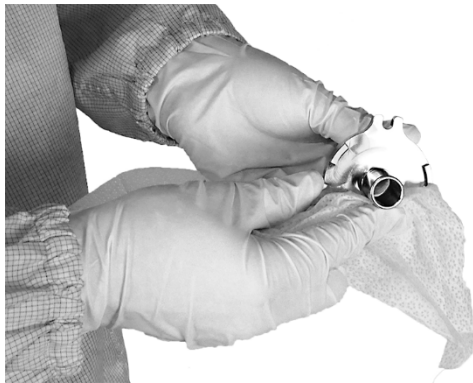

Cleaning cyclone unit and filter unit on the inside and outside

**CAUTION**

**Risk of injury due to sharp edges**

Take care while cleaning the cyclone unit, filter unit and flushing unit. There are sharp edges at connection points and transitions, some of which are required for the device to function. These sharp edges may only be cleaned with a cleaning cloth folded over several times to eliminate the risk of injury.



Cleaning the laboratory bottle

⇒ Clean the laboratory bottle (Pos.4) with an industrial dishwasher or an alcohol-soaked cleaning cloth.

If you do not intend to use the particle suction extraction system after thorough cleaning, close the cyclone unit and the filter unit (on top and at sides) with the plugs to prevent them from becoming contaminated with particles.

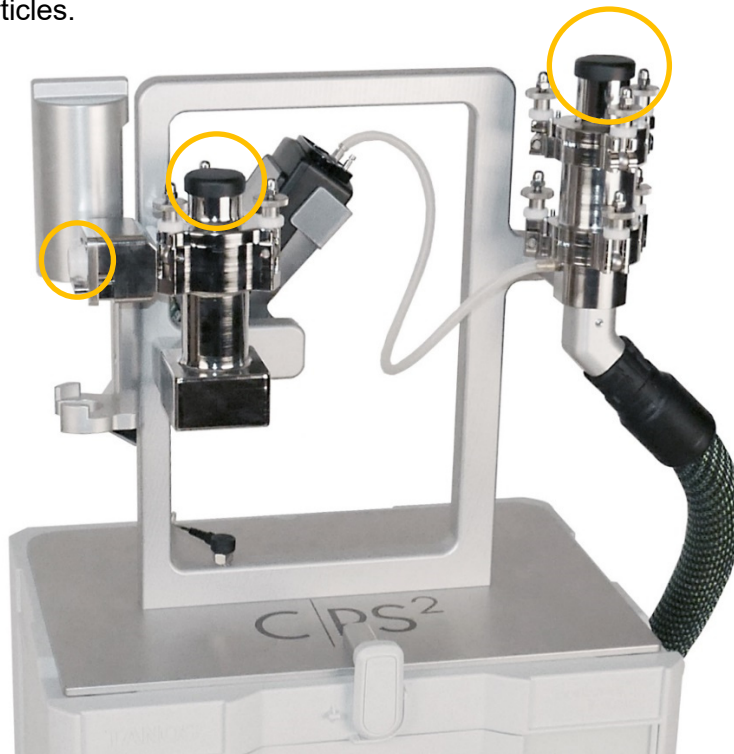

Closed, protected particle suction extraction system, cyclone unit and filter unit

- ⇒ Cover the system with the supplied protective hood to provide optimum protection against contamination from the surrounding environment.



Particle suction extraction system with covering hood



You will also find information on cleaning the particle suction extraction system C|PS<sup>2</sup> into operation and can see the precise procedure in our application video at: <https://bit.ly/3aoSWG9>





## 6.2. Determining the blank value after cleaning



Cleanliness testing on components using extraction entails a risk of not only particles from the test component but also foreign particles not originating from the component affecting the analysis results. If the proportion of foreign particles ("blank value") is too high, this can result in an incorrect evaluation of component cleanliness. The blank value represents the total value for impurities not originating from the component. (Source: VDA 19.1, p. 60)



The user determines the required blank value on an individual basis. Once the blank value specifications have been met, the system is ready for particle suction extraction.

### 6.2.1. Determining the blank value with or without the prefilter

There are different options for determining the blank value:



Determining the blank value with ambient air from the test environment.



Determining the blank value with ambient air from the test environment (blank value from the particle suction extraction system only) by using a prefilter.



Blank value, including the test mat or test surface. The relevant surfaces are actively suctioned while the blank value is determined.



Determining the blank value, suction from the atmosphere



Determining the blank value, suction with prefilter

### 6.2.2. Determining the blank value

- ⇒ Insert a new mesh filter as described in Section 5.3.  
If you are working with the cyclone unit, screw on a clean, empty particle collection jar as described in Section 5.1.
- ⇒ Do not perform particle suction extraction to determine the blank value.
- ⇒ Hold the suction nozzle or brush nozzle with or without prefilter, pointing it upwards into the atmosphere and switch on the suction unit for 2 minutes.
- ⇒ Perform a visual inspection of the filter unit and laboratory bottle. If necessary, rinse or extract the laboratory bottle contents and analyze the mesh filters.

Determining the blank value, suction from the atmosphere



You will also find information on determining the blank value for the particle suction extraction system C|PS<sup>2</sup> and can see the precise procedure in our application video at: <https://bit.ly/3aoSWG9>



## 7. Maintenance

### 7.1. Replacing the suction unit filter and emptying the dirt container

**NOTE**



As parts of the C|PS<sup>2</sup> system may become statically charged during maintenance, all maintenance work must be carried out in a suitable place outside the EPA area.

**CAUTION**

Observe the instructions and safety instructions in the original operating instructions for the FESTOOL suction unit when doing so.

⇒ Remove the suction unit from the ESD trolley – it is removed in the same way as it is installed as described in Section 4.1 but in reverse order.

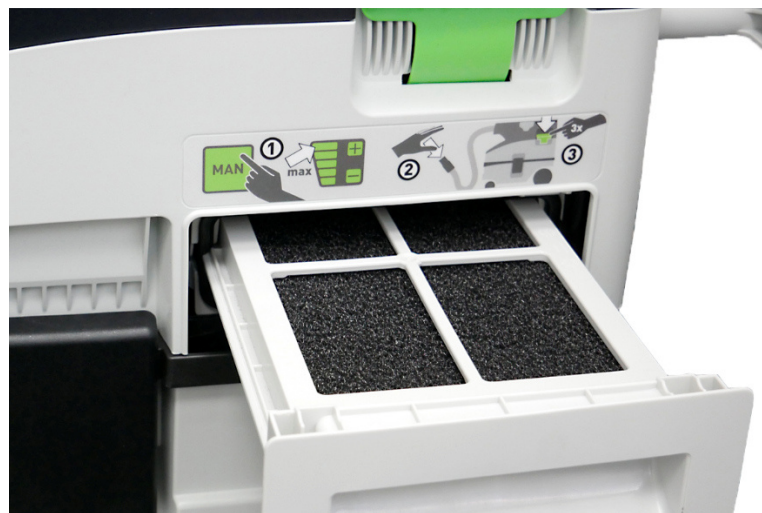

Replacing the mobile dust extractor filter



Emptying the dirt container

Scope of delivery/equipment

## 8. Scope of delivery/equipment

### Basic equipment case

Designation	Art. No.	Number
Particle suction extraction system CPS <sup>2</sup>	6003017	1
Measuring device for vacuum measurement, testo 526-1	61714	1
Plugs for the cyclone unit and the filter unit	6002215	2
Plug for side of cyclone unit	6003028	1
Bluetooth remote control for the suction	6003016	1
ESD protection mat for base plate CPS <sup>2</sup>	6004319	1



Particle suction extraction system with additional equipment in the case system

## SUCTION UNIT

Designation	Art. No.	Number
FESTOOL mobile dust extractor CLEANTEC CTL MIDI I	6002973	1
FESTOOL wet filter NF-CT MINI/MIDI-2	6003015	1



Suction unit

**Drawer 1**

Designation	Art. No.	Number
Tweezers for handling the mesh filters	61364	1
5 µm PET mesh filter for the filter unit	6002095	100
Filter frame and archiving card	61138	20
Waterproof felt-tip pens, black + blue	61759/60	2
Suction nozzle	61783	1
Hand piece for plug-in brush	61784	1
Particle trap adapter	6003170	1
Plug-in brush (brush 20 mm long)	6002302	1
Timer	6003182	1
Laboratory bottle	61574	6



**Analysis and extraction equipment drawer 1**

**Drawer 2**

Designation	Art. No.	Number
Cleaning wire, 2.5 m	61675	1
Cleaning tab	61606	1
Cleaning cloth, alcohol-soaked	6002221	1 pack
Grounding cable	61601	1
Connection hose between the cyclone unit & filter unit, 0.5 m long	6004057	1
Suction hose, 2 m long	6004058	1
Plugs for the hose ends	6002214	6
Protective hood	6003951	1
Washing bottle	6004454	1
Particle traps	30001	2



Measurement and cleaning equipment in drawer 2